TOWING ADVICE & LEGAL OBLIGATIONS



II.1 LEGAL OBLIGATIONS – CABIN & TOWING VEHICLE

II.1.1 TOWING SPEED RESTRICTION

The towing speed limit for this unit is not to exceed 50 mph (80 km/h). The unit is not designed for towing or manoeuvring at higher speeds.

II.1.2 TOWING VEHICLE

The towing vehicle must be suitable for towing the unit. The selection must be made whilst considering the maximum mass (MTPLM) and the towing limit, the Gross Train Weight (GTW) and the load imposed on the rear axle of the towing vehicle.

II.1.3 VIN PLATE

All modern trailer vehicles must carry a manufacturer’s plate giving certain details. From October 2012 this has become part of the European type approval process. The plates must contain information relevant to the loading and towing of the trailer.

The plate is affixed to the front bulkhead of the trailer under the anti-vandal cover.

It contains the Vehicle Identification Number (VIN) which is also marked on the right side of the drawbar.

It also contains the European Type approval reference [3] and details about the mass of the unit.

The maximum mass (MTPLM) of the trailer is shown at position 5 whilst the maximum imposed loading on the coupling is shown at position 6 and the maximum axle load at position 7.

The operator of the trailer should use these weights to determine that the tow vehicle is suitable and that the unit is being used legally.



Number	Refers To
1.	VIN Plate
2.	Vehicle Type Approval
3.	Serial Number
4.	Max Weight
5.	Coupling Rated Mass
6.	Axle Rated Mass

11.1.4 TOWING BRACKET

The towing vehicle must be fitted with a good quality towing bracket, preferably in accordance with Directive 94/20/EC and fitted and used in accordance with the manufacturer's instructions.

11.1.5 REGISTRATION PLATE

The cabin must be fitted with a correctly positioned approved 520 × 120 mm number plate in the place provided. The plate must bear the same registration mark as that of the towing vehicle.

11.1.6 TOWING MIRRORS

Before using a trailer on the road the operator must ensure that the visibility through the rear view mirrors is correct.

The Boss Cabins welfare unit may be wider than the towing vehicle. This means the standard mirrors fitted to the towing vehicle will be inadequate for compliance with the relevant legal requirements.

Extension mirrors must be fitted and adjusted to ensure the yellow shaded area in the diagram is visible in the mirrors for both sides of the vehicle.

Mirrors fitted must be "e" marked and correctly fitted to give adequate visibility.

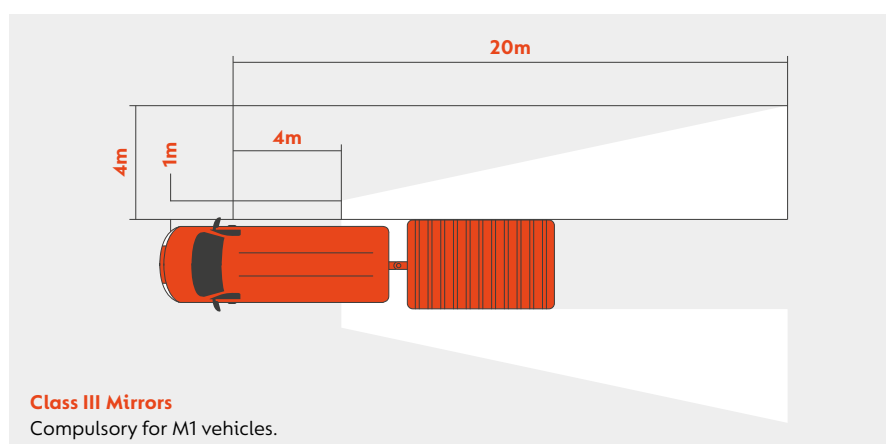
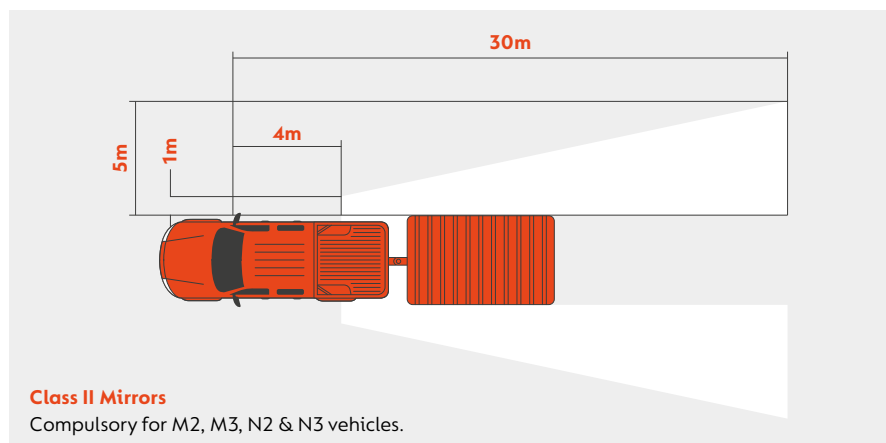

11.1.7 ROAD LIGHTING

It is an offence to tow a trailer or permit a trailer to be towed on the road without adequate and properly functioning lighting.

The trailer is delivered with fully compliant road lighting.

The trailer is connected to the towing vehicle using a standard 13 pin plug and socket.

It is the responsibility of the operator to ensure that all lights are operating and undamaged before using the unit on the public roads.

This class of trailer requires the following lights to be fitted and working.

Number	Type	Colour	Quantity
1.	Number Plate Lamp	White	1 or 2
2.	Mini LED Combination Lamp consisting of:		
2a.	Stop Lamp	Red	2
2b.	Rear Position Lamp	Red	2
2c.	Direction Indication	Amber	2
3.	Mini LED Combination Lamp consisting of:		
3a.	Fog Lamp	Red	1
3b.	Reversing Lamp	White	1
4.	Triangular Reflector	Red	2
5.	End Outline Marker Lamp	Red and White	2
6.	Side Marker Lamp	Amber	4
7.	Front Position (Side) Lamp	White	2

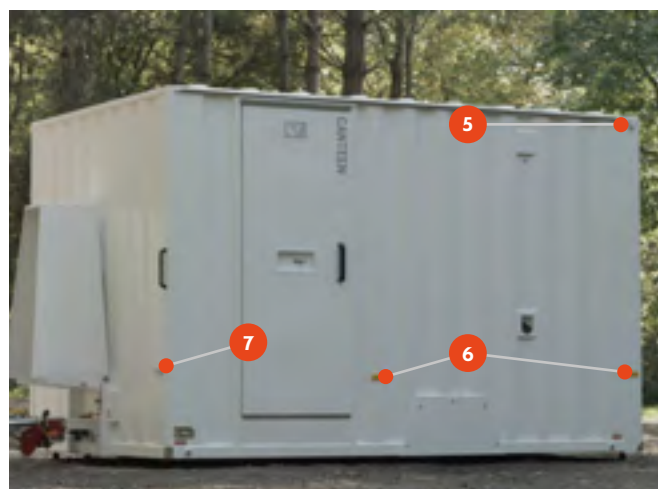
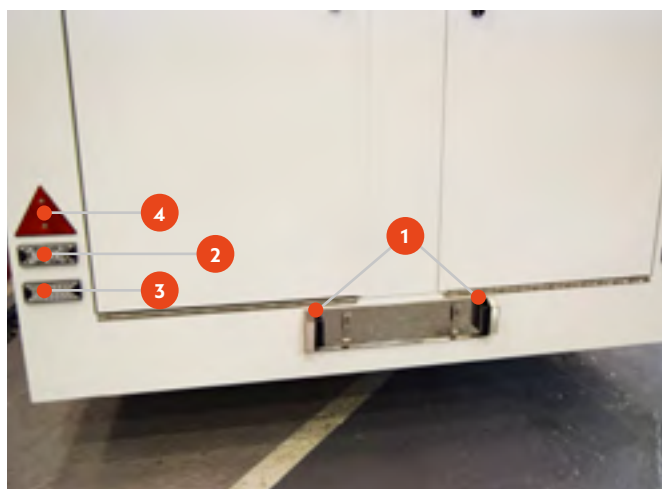

11.2 LEGAL OBLIGATIONS – TOWING VEHICLE DRIVER

People are often ignorant of the towing laws and legal requirements especially when only towing with a standard car licence (Category B).

For photo card licences issued in the UK and other EU countries, the vehicle categories you are entitled to drive are shown on Line 9 on the front. A more detailed breakdown and the applicable dates are shown on the rear.



If you have a B1 or higher category driving licence, you are legally permitted to tow any size of Boss Cabins trailer.

If you have a Category B and BE licence only (awarded on passing the standard UK driving test), check the date your licence was issued and use the following information and flow diagrams to determine what trailers you are able to tow and to match the tow vehicle to the trailer.

MTPLM	Maximum Technically Permissible Laden Mass (of the trailer).
MRO	Mass in Running Order (unladen or ex-works mass).
MAM	Maximum Authorised Mass (Max weight of Towing vehicle).
GTW	Gross Train Weight (Trailer & Towing vehicle weights combined).
MTM	Maximum Towable Mass (the weight a towing vehicle is allowed to tow as indicated by its manufacturer).

CAT B LICENCE HELD BEFORE 1ST JAN 1997

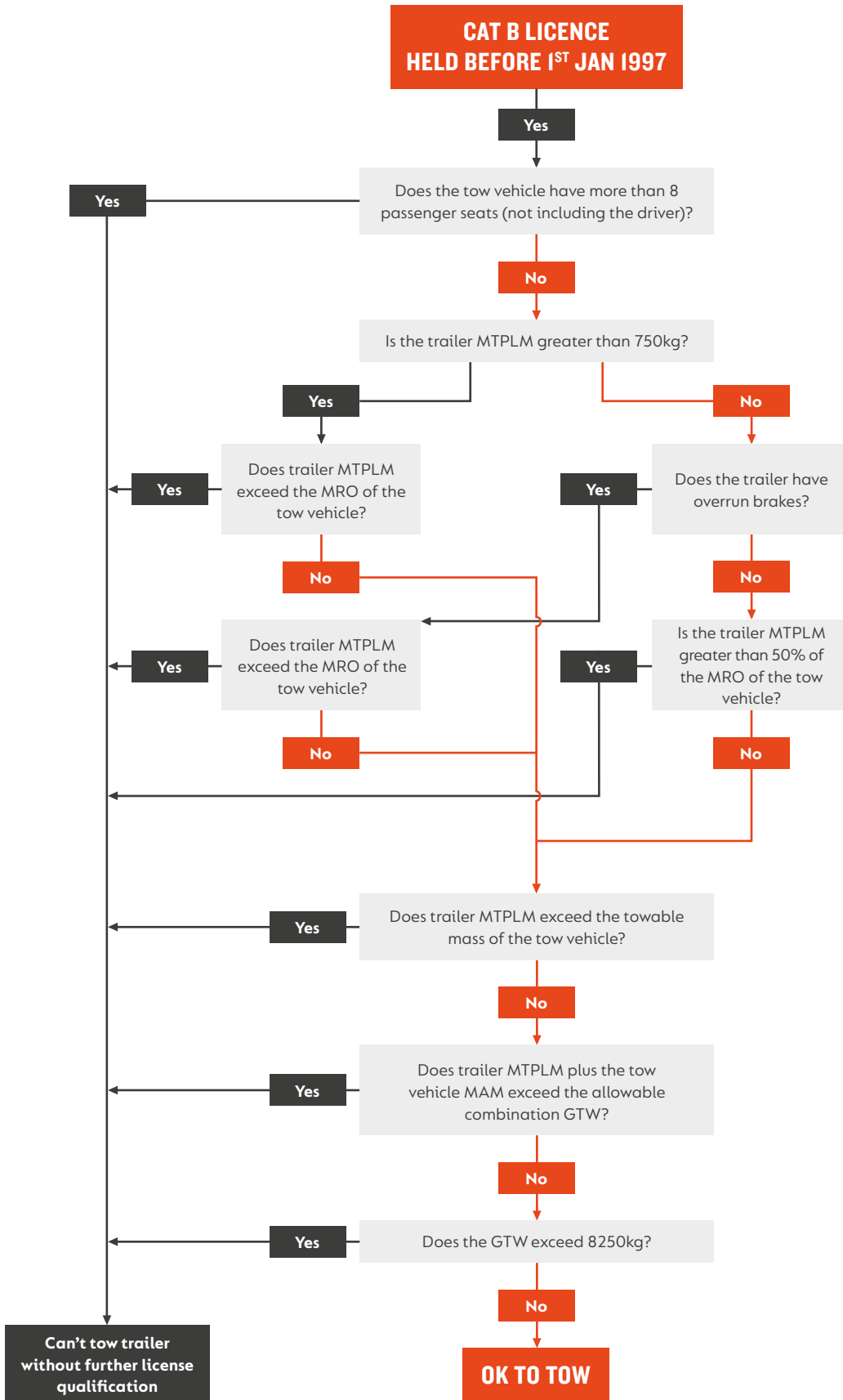

CAT B LICENCE HELD AFTER 1ST JANUARY 1997 BUT BEFORE 19TH JANUARY 2013

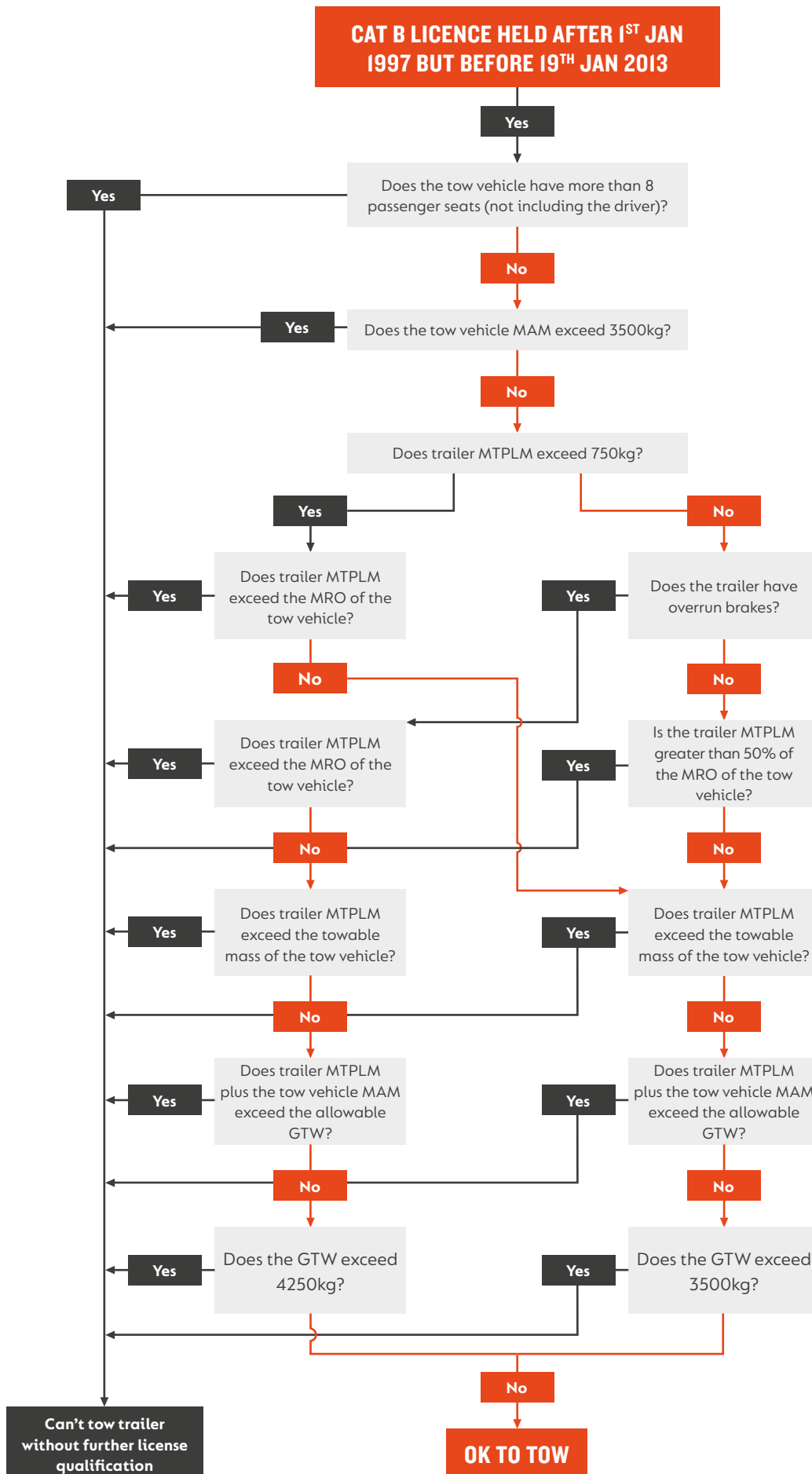

CAT B LICENCE HELD AFTER 19TH JANUARY 2013

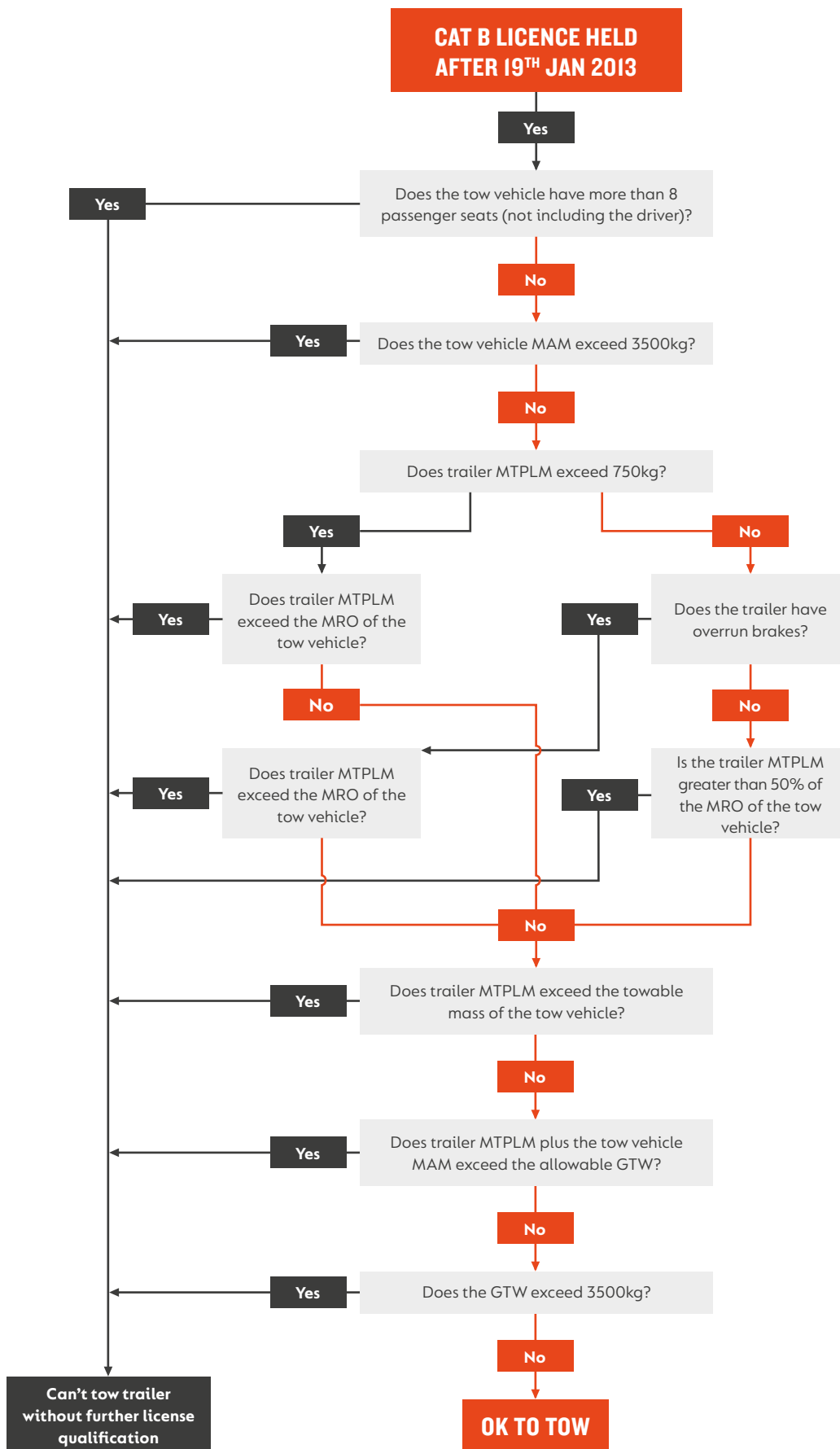

11.3 DRIVING ADVICE

Dependant on the model, Boss Cabins welfare units are equipped with either a single or tandem axle. For inexperienced users this may make manoeuvring difficult, especially where space is limited. Don't take chances, if in doubt and where visibility is limited always get someone to guide or assist you.

The addition of a trailer lengthens the effective wheelbase of the towing vehicle, it may also impair the rearward visibility and make cornering and reversing more challenging.

Boss Cabins strongly recommend that anyone towing one of their welfare units undertakes professional training and accreditation.

11.3.1 TURNING LEFT

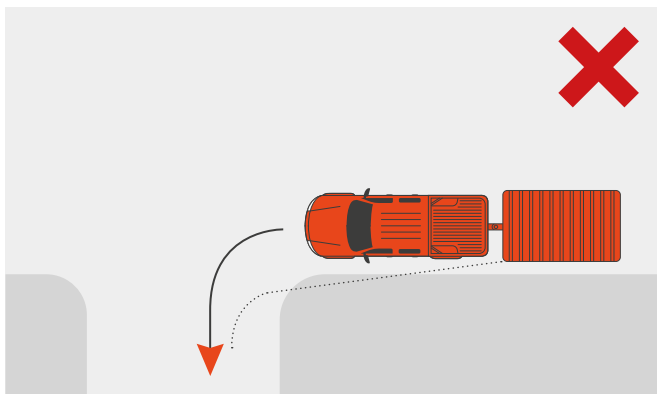

When turning left (in the UK) it is important to remember that the trailer does not take the same route around the corner as the towing vehicle. For example if the towing vehicle is positioned too close to the kerb or the driver does not allow sufficient additional distance when turning, the trailer will cut across the corner. This will inevitably damage the trailer and possibly the towing vehicle.

More seriously it could cause injury to a pedestrian or cyclist, and cause damage to the highway infrastructure.

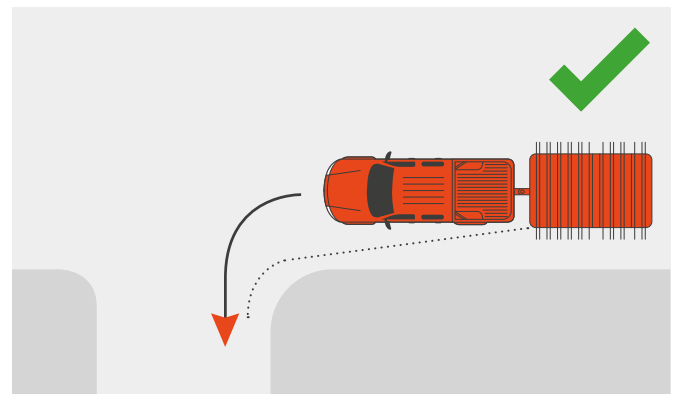

Allow plenty of time to manoeuvre and adjust your road position so as to be further from the kerb, without conflicting with other traffic.

Never overtake slower moving traffic before making a turn. Check your mirrors, especially the left side before making a left turn and ensure there are no cyclists or pedestrians that may be affected by the manoeuvre.

Check the trailer position, and look into the junction to check for any conflicting traffic. Make your turn slightly later than if you were driving without a trailer, this widens the turning circle, allowing the trailer to clear the kerb.

11.3.2 REVERSING THE UNIT

Reversing a trailer requires additional skills, and observation.

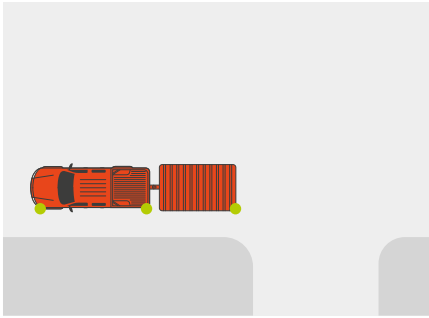

1) Position the towing vehicle parallel to the kerb and if conditions allow, approximately 1m to 1.5m from it.

Allow at least one trailer length from the rear of the trailer to the junction if possible.

Check behind the trailer for any obstructions, then when the road is clear start the manoeuvre by reversing slowly straight back.

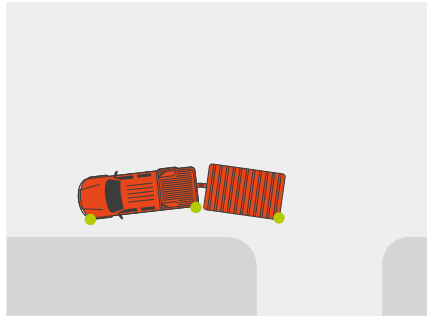

2) Whilst reversing slowly turn the steering wheel opposite to the direction of the turn. Check your mirrors both sides for conflicting traffic and to watch the position of the trailer. As the rear of the towing vehicle turns away from the kerb, watch the rear of the trailer and it will start to turn into the junction.

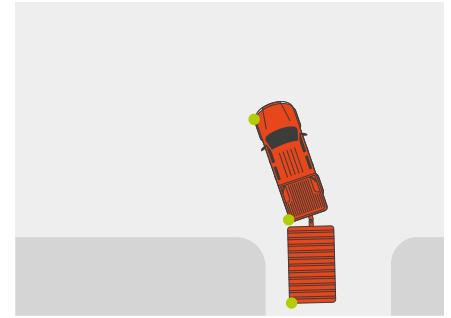

3) As the trailer starts to turn, turn the steering wheel into the normal lock for the curve. Follow the trailer into the junction.

If the trailer starts to turn in too tightly, turn the steering wheel further to the left to correct it.

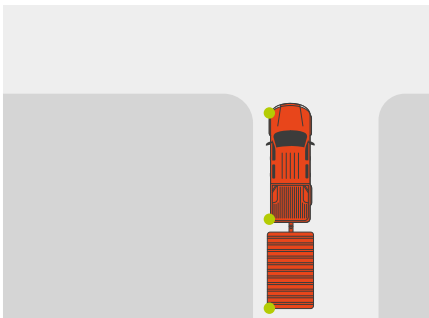

4) When fully into the junction, turn the steering to the left to straighten up the trailer.

You may need to steer further to the left than is normal to compensate for the trailer, so ensure you use your mirrors to look for conflicting traffic and obstructions.

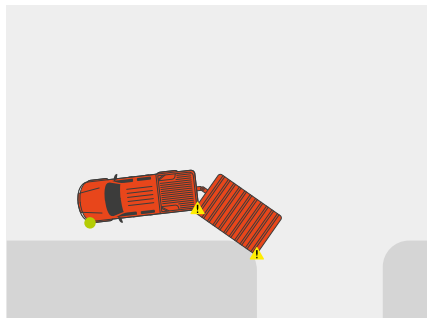

CAUTION

If you lose control of the trailer whilst reversing, the most likely result will be to jack-knife. This is where the trailer turning circle decreases quickly and the towing vehicle cannot steer to correct it. In this condition the only method of correction is to stop, then pull forward to straighten up the trailer, then start the reversing procedure again.

Jack-knifing the trailer can cause instability, and inevitably causes damage to trailer and the towing vehicle.